

Blade Version Tri-proof TB33

Blade version tri-proof is a modular design, openable and sustainable luminaire, so that we could benefit by more possibilities, easier maintenance, and less CO2 emission. It's recommended as an ideal solution to a lot of applications such as parking lots, factory, warehouses Industrial areas..

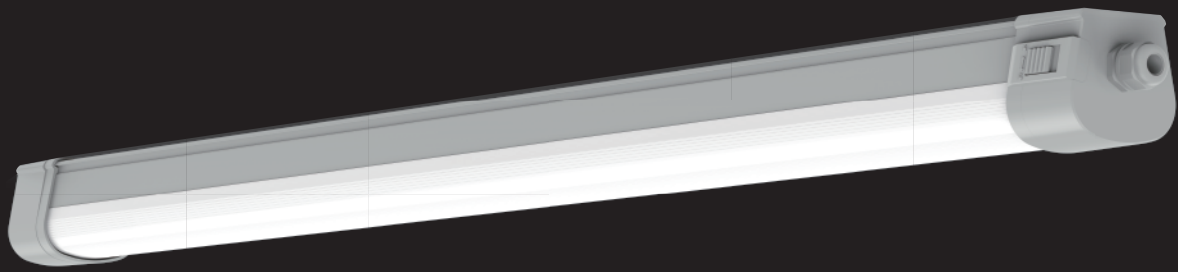

Feature

- MultiLumen with power adjustable
- Tool-free and fast installation
- 3/5 Through-wiring
- High efficiency up to 160lm/W
- DIN EN 60598-2-24 D mark available
- Flicker free





3/5 push-on terminals
1.5&2.5mm² Through-wiring

Silicone gasket
Stable water-proof

Injection polycarbonate end cap



UL94 V0 fire proof
Glow wire 850 °C



Easy twisting open&close



Smart spring locking

M20 cable gland

OPENABLE LUMINAIRE

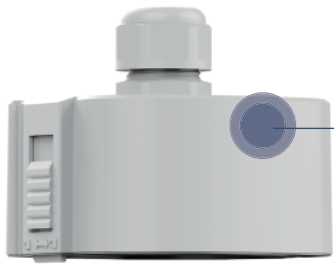

Toolless openable end cap

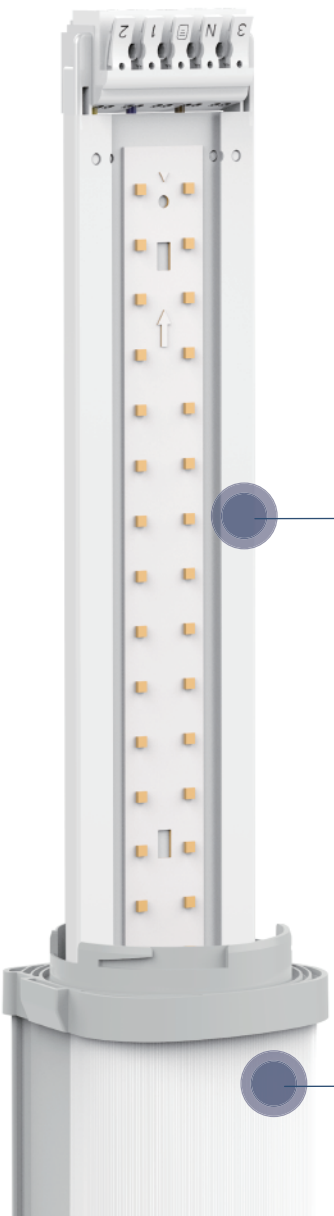

Easy access to the gear tray

IK08 impact proof polycarbonate

OPTIC

- + Efficacy 160lm/w
- + Up to 10080lm
- + Ra > 80

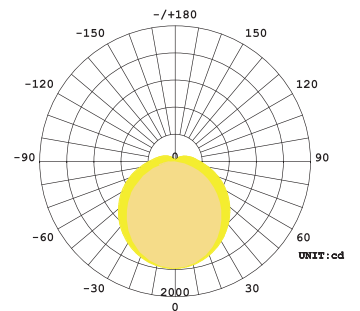

Dimension

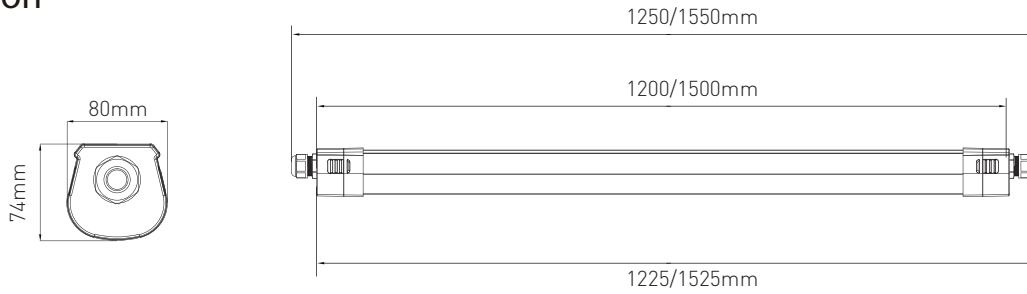

Standard version(Power adjustable)

Model NO. / Length	Power adjustable(W)	Multiple Lumens 160lm/W
TB33 / 1200mm	25/32/38/45	4000/5120/6080/7200
TB33 / 1500mm	35/44/53/63	5600/7040/8480/10080

AC Input	220-240V 50/60Hz
Light Source	SDCM<3
CRI Range	80 / 90 / 95
CCT Range	WW(3000K) NW(4000K) DW(5000K) CW(6500K)
Light Efficiency	160lm/W
Beam Angle	120°
Lifespan	102000h L80B10 / 118000h L80B50 @Ta 25°C
Size	80(L)*74(H)
Waterproof	IP65 & IK08
Warranty	5 years

DALI version

Model NO. / Length	Power (W)	(Frosted Cover) Lumens 150lm/W
TB33 / 1200mm	40	6000
TB33 / 1200mm	45	6750
TB33 / 1500mm	50	7500
TB33 / 1500mm	63	9450

MCB (Standard version)

45W : MCB B10A 20, MCB B16A 32, MCB C10A 34, MCB C16A 54
 63W : MCB B10A 20, MCB B16A 32, MCB C10A 34, MCB C16A 54

Accessory



01



02



03



04



05



06

Accessories	IMAGE	DESIGNTION	MATERIAL	QUANTITY	ACCESSORY USE
Standard	01	Ceiling Mounting Bracket	Stainless steel	2PCS	For ceiling mounting and suspension using
Standard	02	Screw	Stainless steel	2PCS	For ceiling mounting using
Optional	03	Suspension Cable	Stainless steel	2PCS	For suspension using
Optional	04	Waterproof Rubber Plug	PC	1PCS	For through-wiring using
Optional	05	M20 Connector	PC	1PCS	For through-wiring using
Optional	06	Nordic bracket	Stainless steel	2PCS	For ceiling mounting and suspension using

Wiring

• Standard

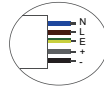
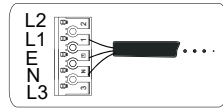

Note:
 Gray "Dim+"
 Black "Dim-"
 Brown "L"
 Blue "N"
 Green+Yellow "E"

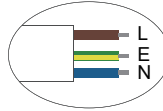
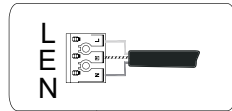

Note:
 Brown "L"
 Blue "N"
 Green+Yellow

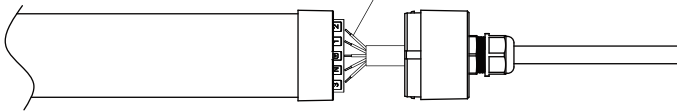

• Through-wiring

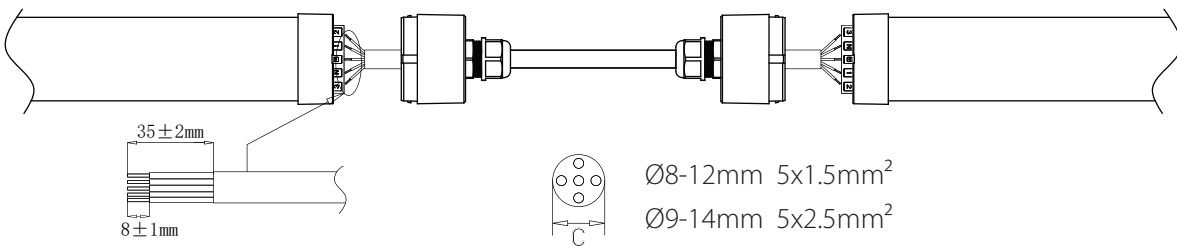

Installation

1 Ceiling Mounting

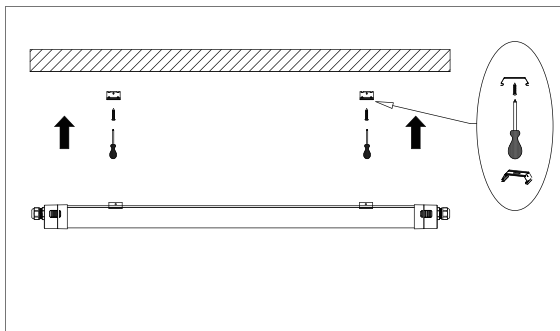

2 Suspension

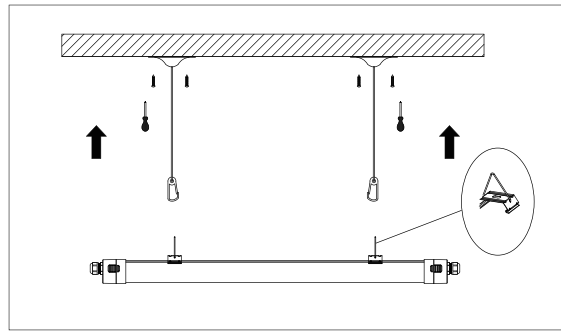





— Please Note: All the operations must be in the condition of power off

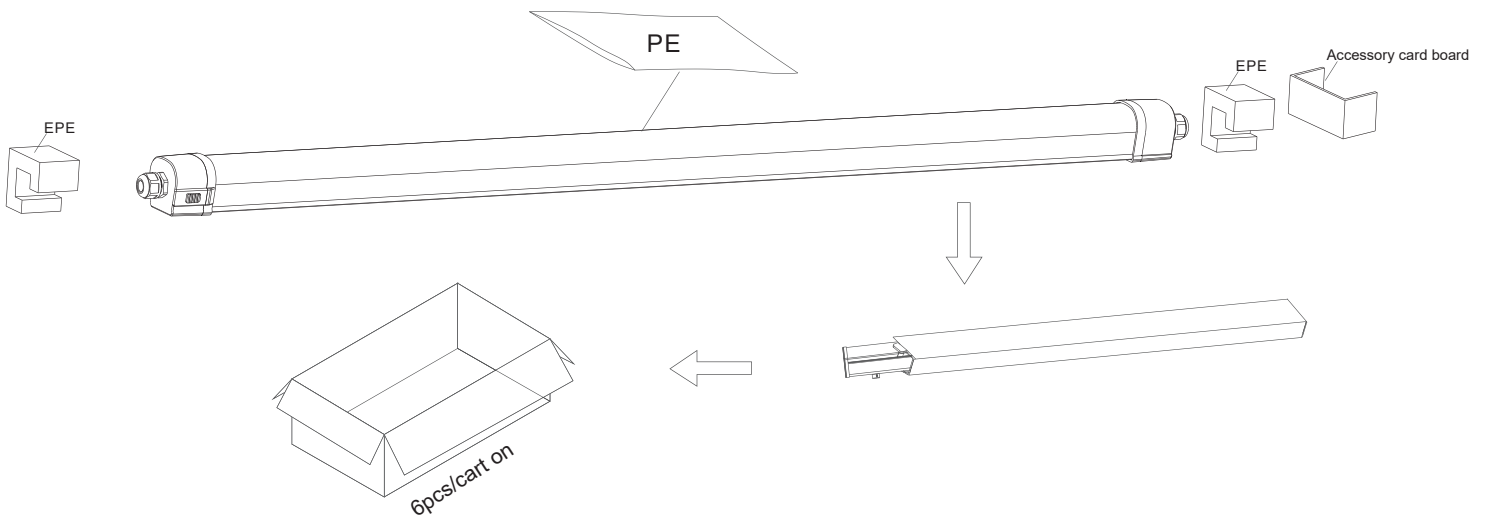

—  The luminaires are intended for indoor use. If you don't understand anything, please consult the sales staff.

Packaging



Dimensions and logistics

Description	Shipping carton	 Pcs./Box	 KG	 pallet	 pallet
	L x W x H mm	Box	Box	L x W x H mm	Pcs./pallet
TB33 1200	1324*297*194	6	10.5	1350*960*2070	180
TB33 1500	1624*297*194	6	12.7	1650*960*2070	180

Shipping reference	20' 	40' 	40'HQ 
TB33/1200 (pallet)	1800 PCS	3600 PCS	/
TB33/1500 (pallet)	1080 PCS	2520 PCS	/
TB33/1200 (Without pallet)	2424 PCS	/	5832 PCS
TB33/1500 (Without pallet)	1968 PCS	/	4698 PCS

Attention

This specification is for reference only, we reserve the right to change without notice. If you need the updated info, please contact local distributors or visit our website at <http://www.ervan.cn>

This product is non-resistant to some chemical substances, please contact the manufacturer for the details.

Statement

According to the International Standard of LED luminaire, here ERVAN formally claims that ERVAN LED Tri-proof (Weather proof) series products is only allowed to be applied to indoor neutral environment. Meanwhile ERVAN promises full warranty for the products.

Any severe environment application including high/low temperature, high humidity, high salinity, high-ammonia etc. is not permitted without the official confirmation from the manufacturer. If any misapplication happens, the warranty policy is no longer guaranteed.

ERVAN reserves the right of final explanation.